

MTP® Multi Tuff Trunk Assemblies

MTP® Multi-Tuff Trunk assemblies offer exceptional fibre counts from 48f up to 144f, all contained within one robust trunk link assembly. Typical configurations of up to 12x 12f MTP® to 12x 12f MTP® or 6x 24f MTP® to 6x 24f MTP® assemblies can be provided. The Multi-Tuff trunk provides exceptional durability when compared to traditional MTP® trunk cable, with a crush resistance of 2000N and tensile strength in excess of 1500N. The colour coded tails can either be left flush or staggered to fit a protection sock for prudent installation practices. The sock then fits to the break-out manifold ensuring the tensile loading is not on the fibres during or post installation.

The cable construction consists of up to 12x 12f tubes managed around a central strength member. The cable is packed with aramid yarn for added protection and an outer black LSZH universal jacket. The manifold is fitted with a anti kink strain relief boot and with its threaded front, fits into a 20mm capillary much like a cable gland making these assemblies equally suitable for indoor and outdoor applications.

Manufactured within our state-of-the-art termination facility where meticulous attention to detail provides assured quality and peace of mind. From our North Wales base, fast-manufacturing turnaround is our speciality with custom length assemblies made within days of ordering.

Multi Tuff Trunks are robust and therefore suitable for pulling into position by way of Draw Wires or Duct Rods.



Features & Benefits

- Exceptionally High Density Connectors – 12 or 24 fibre set in a SC Simplex Format
- Higher Density Population reduces the over cost of 1U Spacing
- Rapid deployment modular system saving overall installation and maintenance time
- Multimode OM3, enhanced OM4 and OS2 fibre grades with a LSZH jacket
- Removable housing for field change of polarity and gender (separate tool required)
- MTP® patented elliptical guide pins are key to accurate mating alignment and determine the gender or the connector; male or female
- The oval spring provide greater fibre clearance and seats into the connector body eliminating possible trapping/breakages of bare fibre
- High Spring Force (HSF) MTP® connectors ensuring uniform alignment across 24x lanes and optimising the physical contact
- Choosing MTP® Elite provides performance for the most stringent of optical loss budget environments
- 100% interferometric testing for all MTP® Connectors to verify end-face geometry conformity and subsequent low losses
- Fully compatible with all MPO connectivity and QSFP+ mated interface solutions with the same fibre count

Specification

ELEMENT	CHARACTERISTIC
Fibre (ISO/IEC 60793)	OS2 = Black Cable - Yellow Tails OM3 + OM4 = Black Cable - Aqua Tails
Cable OD (LSZH)	Up to 60f = 10.4mm, 72f = 11.2mm 84f ~ 96f = 12.6mm, 108f ~ 144f = 16mm
Housing (US Conec)	Multimode Elite = Aqua, Single-mode Elite = Yellow
Crush Resistance (cable)	2000N
Operation Temperature	-40 ~ +80°C
Installation Temperature	-10 ~ +70°C

Industry Standards Compliance

- Colour coding compliant to TIA/EIA-568-C.3 & ISO/IEC11801
- MTP® Connector specification to IEC-61754-7 & EIA/TIA-604-5
- Jacket materials to IEC 60332
- Compliant to Directive 2002/95/EC (RoHS) and REACH SvHC
- The geometrical characteristics compliant to IEC-60793
- End Face Cleanliness compliant to IEC 61300-3-35

Application

- Data Centre Infrastructure
- Storage Area Network – Fibre Channel
- Parallel Optics
- 40Gbps, 100Gbps and emerging 400Gbps Protocols

Optical Fibre Specifications

Multimode Fibres

Multimode Fibres IEC 60793-2 ISO/IEC 11801 EN 50173 -1&2	Overall Bandwidth (MHz x km)		Max. Link Length for 1 GBit/s (m)		Max. Link Length for 10 GBit/s (m)		Fibre Attenuation (dB/km)	
	850nm	1300nm	850nm (1000Base-SX)	1300nm (1000Base-LX)	850nm (10GBase-SR) (10GBase-SW)	1300nm (10GBase-LX4)	850nm	1300nm
50/125 um								
OM3	≥1500	≥500	1000	600	300	300	≤2.7	≤0.7
OM4 Laser Optimised	≥3500	≥500	1000	600	550	300	≤2.7	≤0.7

Single-mode Fibres

Single-mode Fibres IEC 60793-2 ISO/IEC 11801 EN 50173 -1&2	Chromatic Dispersion		Cut-off-Wave Length (cabled) (nm)	Point Discontinuity (dB)	Fibre Attenuation (dB/km)			Fibre Geometrical Properties (um)		
	1310nm	1550nm			1310nm	1380-1386nm	1550nm	Mode-field	Cladding	Coating
9/125 um										
OS2(ITU-T G.652.D)	≥3.5	≥18.0	≥1260	≤0.1	≤0.34	≤0.31	≤0.22	9.2 ±0.4	125 ±1	245 ±5
OS2 (G.657.A2)	≥3.7	≥18.5	≥1260	≤0.1	≤0.38	≤0.35	≤0.25	8.8 ±0.4	125 ±1	245 ±5

Part Numbering Format

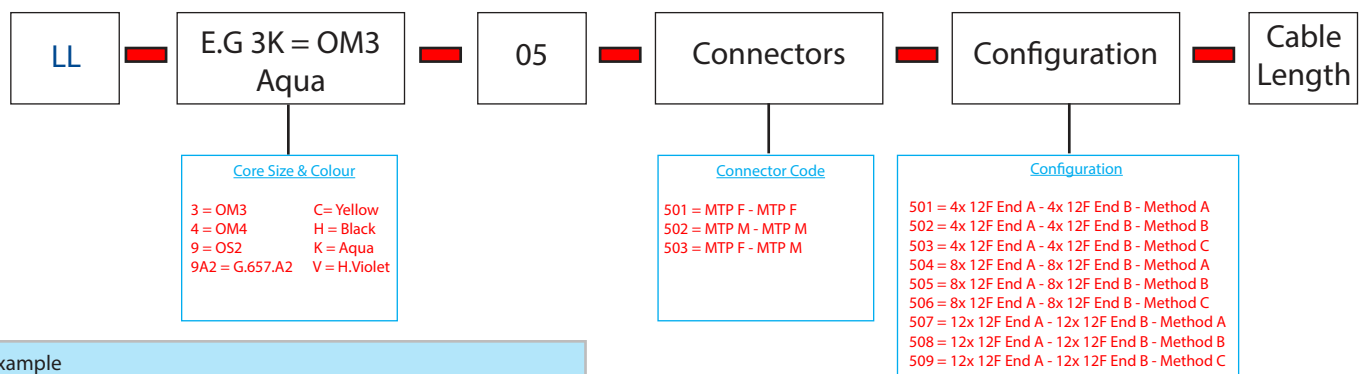

Example
 LL-9H-04-401-402-065
 Lite Linke Harness - 65m 4x12f MTPF - 4x 12f MTPF OS2 - Method C
 Standard Design = Staggered Tails with Protective Tubing

Connectivity Methods

All the connectivity methods shown here have the same purpose: to ensure that the transmit port of one device is connected to the receive port on another device. Each method requires a specific combination for components to maintain the system polarity. These are outlined in the below table.

Method	Connector Type	Adapter Type	Patch Cord Type
A	MTP®	Key Up - A - Key Down	One A-to-B and One A-to-A
B	MTP®	Key Up - B - Key Up	A-to-B
C	MTP®	Key Up - A - Key Down	A-to-B

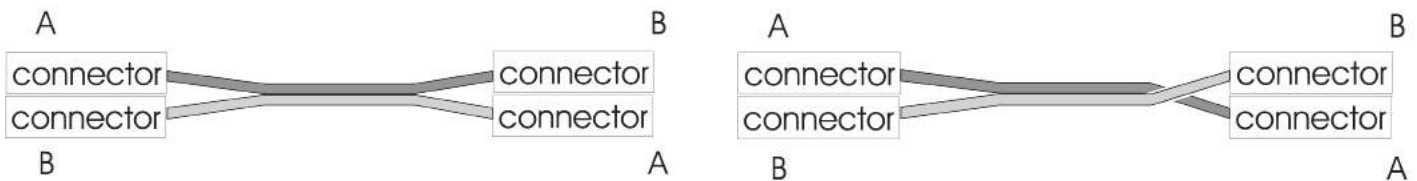

*Retro Polarity change from A-B or B-A is only applicable for MTP multimode connector due to MTP Single-mode connectors are Angle Polished

MTP® Connector Performance

CONNECTOR MATING	INSERTION LOSS TYPICAL	INSERTION LOSS MAX	RETURN LOSS
MTP® MM Elite	0.10dB	0.35dB	N/A
MTP® SM Elite	0.10dB	0.35dB	>60dB

Certificates



Certified & Trained



Certificate Number 3927
ISO 9001:2008



MTP® is a Registered Trademark of US Conec

Kevlar® is a Registered Trademark of Dupont™

Available Accessories



MTP® Harness Assemblies



MTP® 1U CHASSIS



MTP® Cleaning Solutions



MTP® Modular Cassette



MTP® 3U CHASSIS

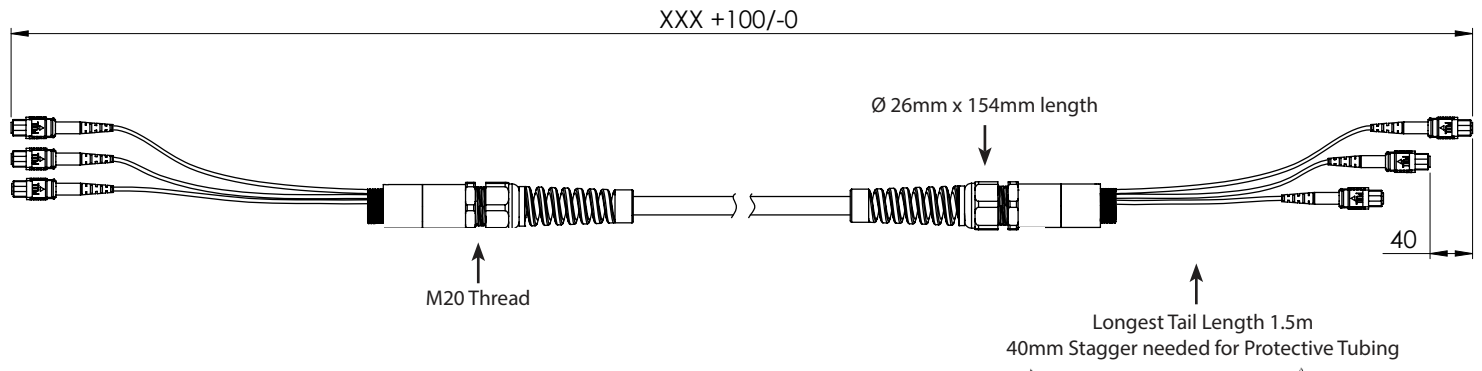
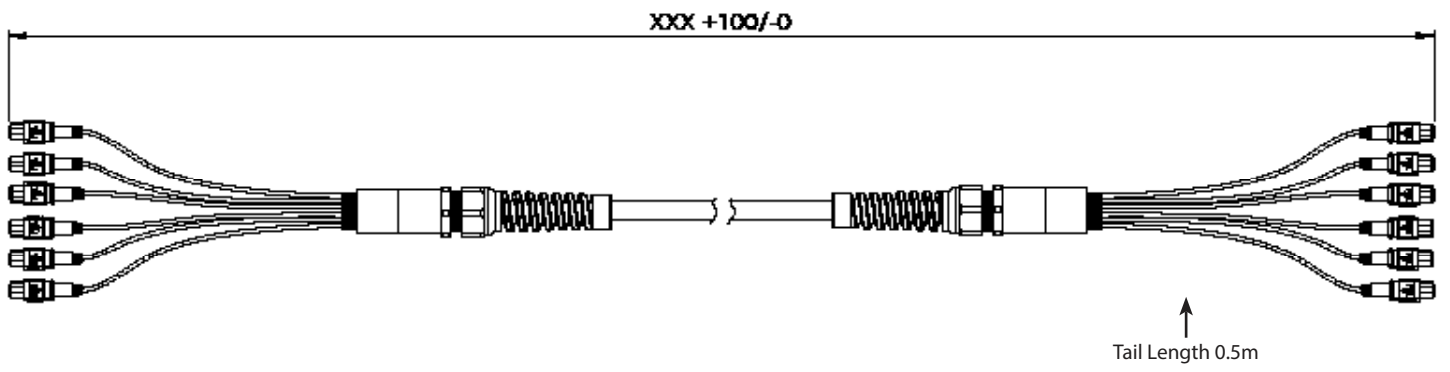
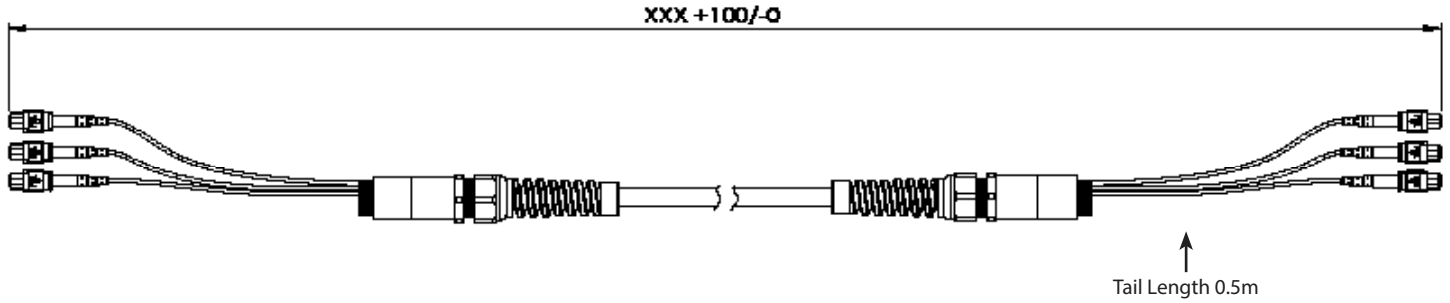

Lite Linke Standard Configuration
Staggered Tails and Protective Tube

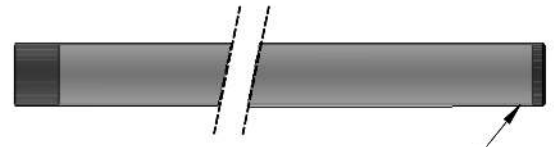

MTP® Trunk Assembly Methods

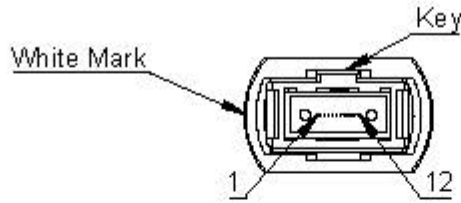

Method A		
Colour	Fibre #	Colour
Blue	1	Blue
Orange	2	Orange
Green	3	Green
Brown	4	Brown
Slate	5	Slate
White	6	White
Red	7	Red
Black	8	Black
Yellow	9	Yellow
Violet	10	Violet
Pink	11	Pink
Aqua	12	Aqua

Method B		
Colour	Fibre #	Colour
Blue	1	Aqua
Orange	2	Pink
Green	3	Violet
Brown	4	Yellow
Slate	5	Black
White	6	Red
Red	7	White
Black	8	Slate
Yellow	9	Brown
Violet	10	Green
Pink	11	Orange
Aqua	12	Blue

Method C		
Colour	Fibre #	Colour
Blue	1	Orange
Orange	2	Blue
Green	3	Brown
Brown	4	Green
Slate	5	White
White	6	Slate
Red	7	Black
Black	8	Red
Yellow	9	Violet
Violet	10	Yellow
Pink	11	Aqua
Aqua	12	Pink

MTP® 24f Trunk Assembly Methods

(Crossed)		
Row A	Colour	Row B
A1	Blue	B1
A2	Orange	B2
A3	Green	B3
A4	Brown	B4
A5	Slate	B5
A6	White	B6
A7	Red	B7
A8	Black	B8
A9	Yellow	B9
A10	Violet	B10
A11	Pink	B11
A12	Aqua	B12
B1	- Blue -	A1
B2	- Orange -	A2
B3	- Green -	A3
B4	- Brown -	A4
B5	- Slate -	A5
B6	- White -	A6
B7	- Red -	A7
B8	- Black -	A8
B9	- Yellow -	A9
B10	- Violet -	A10
B11	- Pink -	A11
B12	- Aqua -	A12

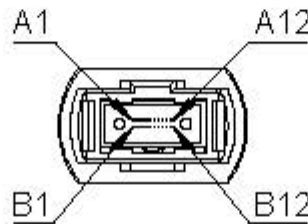

(Straight)		
Row A	Colour	Row B
A1	Blue	A1
A2	Orange	A2
A3	Green	A3
A4	Brown	A4
A5	Slate	A5
A6	White	A6
A7	Red	A7
A8	Black	A8
A9	Yellow	A9
A10	Violet	A10
A11	Pink	A11
A12	Aqua	A12
B1	- Blue -	B1
B2	- Orange -	B2
B3	- Green -	B3
B4	- Brown -	B4
B5	- Slate -	B5
B6	- White -	B6
B7	- Red -	B7
B8	- Black -	B8
B9	- Yellow -	B9
B10	- Violet -	B10
B11	- Pink -	B11
B12	- Aqua -	B12